



SE/SAFE LA40-DC

- Heavy Duty Housing
- Low Power Consumption
- Long Life LED's
- Low Maintenance
- Designed for Offshore Use

The LA series is a highly efficient and rugged LED light fixture for harsh offshore conditions.

The versatile design with four optical variations can be used for different applications such as work & walkway lights, ID sign lights, etc.

Utilizing low power to provide high output, the LA series is rugged and low maintenance.

Dimensions & Weight

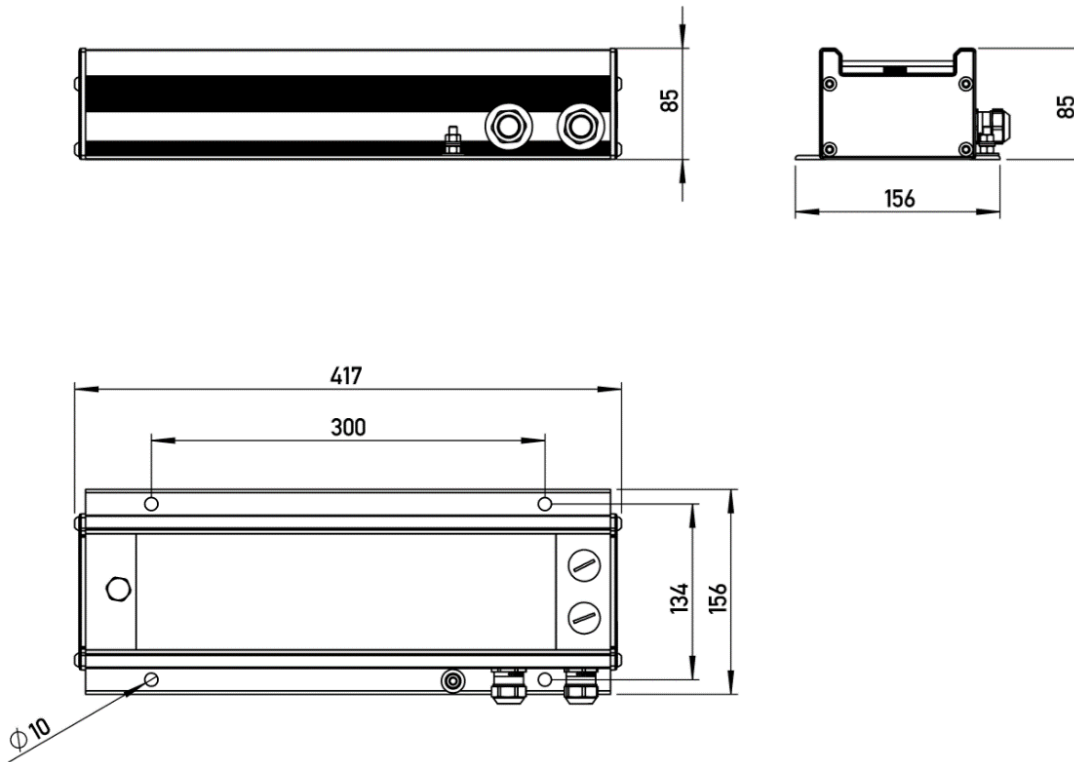

Height	85 mm
Width	156 mm
Length	417 mm
Weight	2,6 kg

Material

Housing / Profile	Extruded Seawater resistant anodized aluminum
End Lid	Stainless steel 316 L / 1.4404
Gasket	TPE-K UV-AD2 TC5MUZ
Glass	UV resistant clear polycarbonate

Optical System

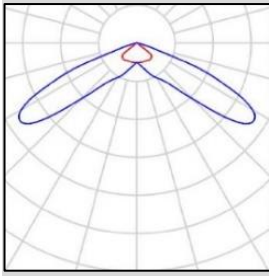
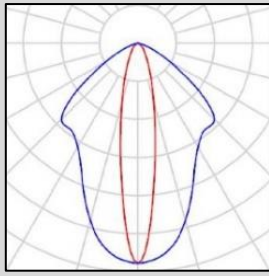
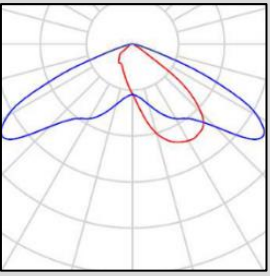
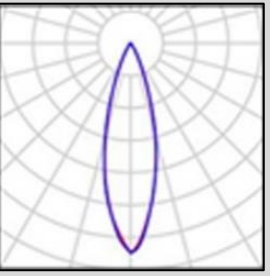
Variant	Extra Wide	Narrow	Asymmetric	Medium Spot
Product ID	LA40-DC XW	LA40-DC N	LA40-DC AS	LA40-DC MS
Lumen	15 W, 40%	600 lm	680 lm	500 lm
	22 W, 70%	1050 lm	1190 lm	800 lm
	30 W, 100%	1500 lm	1700 lm	1200 lm
Color Temperature	4000 K	4000 K	4000 K	4000 K
Lamp group (acc. to EN 61471:2008)	RG1	RG1	RG1	RG1
Optical Profile				

Note: blue = horizontal distribution; red = vertical distribution

Electrical Connection

Type	Operating Voltage	Power Consumption	Details
Supply	DC 20 to 30 V	30 W	93% at 100% luminosity
Control Signal	DC 20 to 30 V	< 5 mA	PWM of maximum 200Hz and a Duty cycle greater than 10%

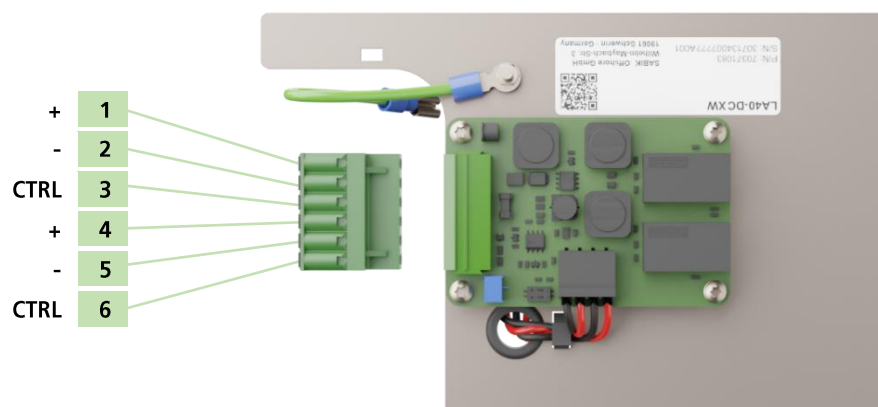

* Max. 5 units on 16 A circuit breaker at 24 V DC

Components

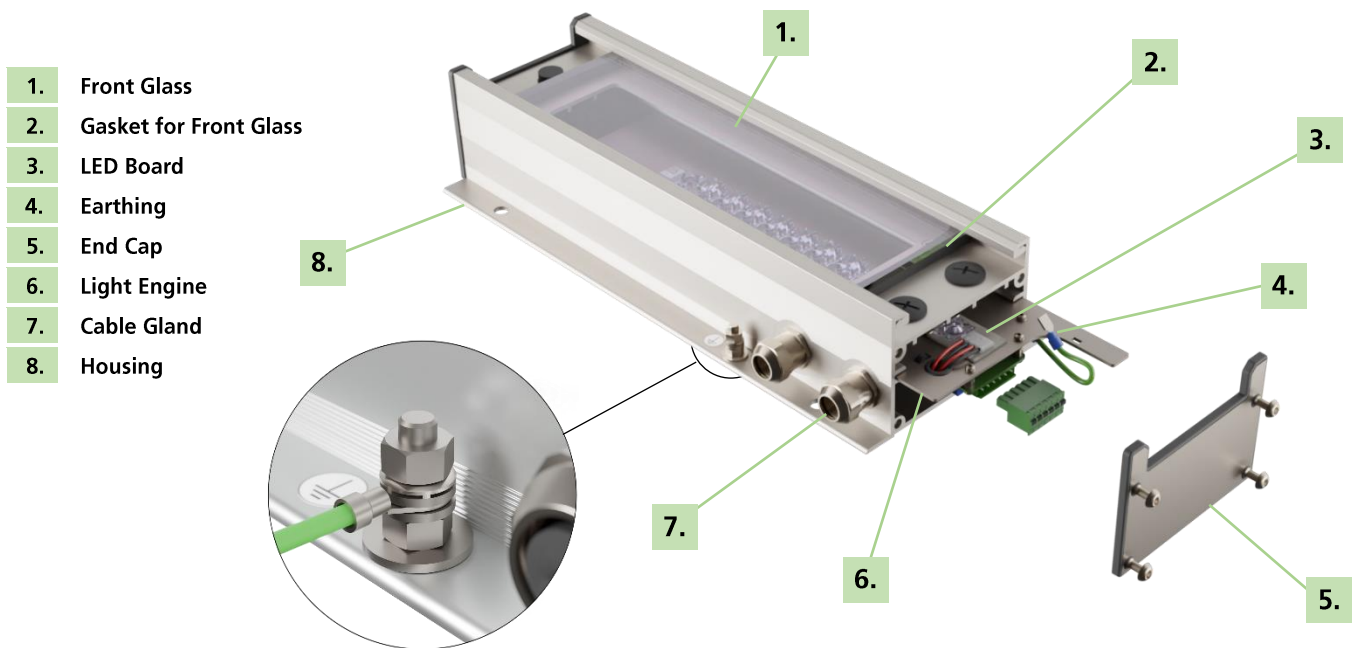

- 1. Front Glass
- 2. Gasket for Front Glass
- 3. LED Board
- 4. Earthing
- 5. End Cap
- 6. Light Engine
- 7. Cable Gland
- 8. Housing

	Size	For cable diameter	Key width
EMC Cable Gland	M20 x 1.5	8.0 – 15.0 mm	24 mm

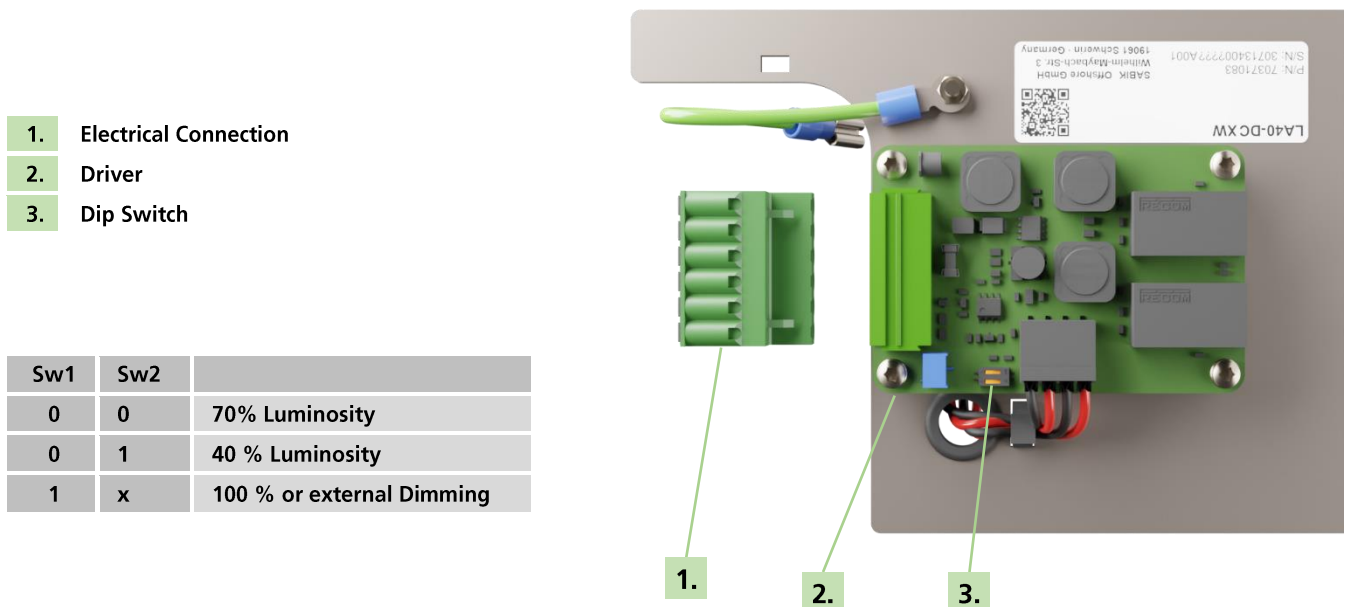

- 1. Electrical Connection
- 2. Driver
- 3. Dip Switch

Sw1	Sw2	
0	0	70% Luminosity
0	1	40 % Luminosity
1	x	100 % or external Dimming

Environmental Conditions

Ambient temperature (operation)	-25°C to 55°C
Ambient temperature (storage / transport)	-25°C to 70°C
Humidity (operation / storage / transport)	95% r.h. up to 45°C 70% r.h. for T > 45°C
Atmospheric pressure (operation / storage / transport)	80 kPa to 108 kPa
Degree of protection (acc. To IEC 60529)	IP66 & IP67
Luminaire classification (acc. to EN 60598-1:2018)	Rough service luminaire

Electrical Safety & Health

Protection class	Class I
Overvoltage protection	Class III
Pollution degree	3

Compliance

Electromagnetic Compatibility	EN 60945:2002, category "exposed" EN 61547:2009 EN 61000-6-2:2005 EN 61000-6-4:2007 + A1:2011
Environmental	EN 60945:2002, category "exposed" EN 60598-1:2015 + A1:2008 IEC 61892-1:2019
Product Safety	EN 60598-1:2015 + A1:2018 EN 60598-2-1:1989
Health	EN 62471:2008
Mechanical	EN 60945:2002, category "exposed" EN 60598-1:2015 + A1:2018 IEC 61892-1:2019 IEC 61892-3:2019

Reliability

Minimum LED lifetime	60 000 h
----------------------	----------

Ordering Information

Item Number	Product ID	Variant	Optic
30713400	LA40-DC	XW	Extra Wide
30713401	LA40-DC	N	Narrow
30713403	LA40-DC	AS	Asymmetric
30713404	LA40-DC	MS	Medium Spot